

H2

Video Wall Splicer

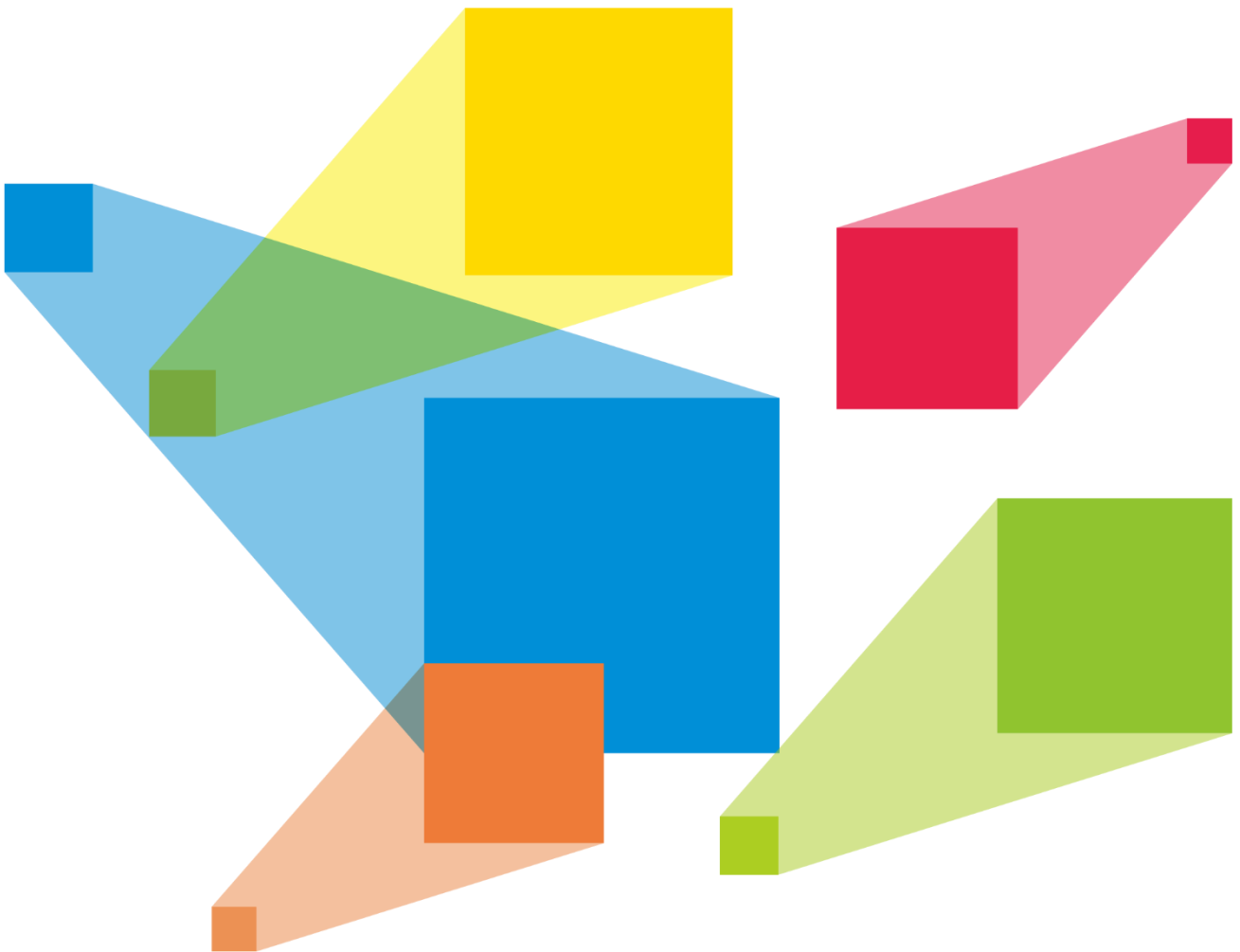

Specifications

Change History

Document Version	Release Date	Description
V1.8.0	2023-02-17	Added the description of the H_4xfiber sending card.
V1.7.0	2022-12-05	<ul style="list-style-type: none"> Added the descriptions of the H_4xDVI output card, H_4xHDMI output card and H_1xHDMI2.0 output card. Updated the decoding capability description of the H_2xRJ45 IP input card.
V1.6.0	2022-04-30	<ul style="list-style-type: none"> Added the section of Notes and Cautions. Updated the certifications. Added the description of the H_1xDP1.2 input card.
V1.5.2	2021-08-30	<ul style="list-style-type: none"> Added the description of the low latency function. Added the notes for use of the USB connectors and COM port. Updated the certifications.
V1.5.1	2021-06-10	Added the description of ordering or purchasing the optical module for the H_16xRJ45+2xfiber sending card.
V1.5.0	2021-04-30	Added the description of the H_1xHDMI2.0 input card.
V1.4.0	2021-03-31	<ul style="list-style-type: none"> Added the descriptions of the H_1x12G SDI input card and H_1xHDMI2.0 output card. Added the descriptions of the following new features: <ul style="list-style-type: none"> XR scenario control Device backup and LED 4K sending card backup
V1.3.1	2021-01-08	Added one HDMI cable to the product accessories.
V1.3.0	2020-11-30	<ul style="list-style-type: none"> Added the description of H_STD I/O card. Deleted the maximum screen quantity and added the maximum layer quantity in the specification table. Changed the maximum widths and heights supported by the dual-link DVI and HDMI input and output connectors.
V1.2.0	2020-09-04	<p>Added the descriptions of the following cards:</p> <ul style="list-style-type: none"> H_2xDP1.1 input card H_20xRJ45 sending card
V1.1.1	2020-08-20	Updated the maximum height supported by the H_16xRJ45+2xfiber sending card to 10240 pixels.
V1.1.0	2020-07-31	<ul style="list-style-type: none"> Added the descriptions of the following new functions: <ul style="list-style-type: none"> Eye saver mode on Web page 3D function Input source grouping and decimal frame rates App control on the pad device Added the descriptions of the following input cards: <ul style="list-style-type: none"> H_4x3G SDI input card H_2xCVBS+2xVGA input card H_4xVGA input card
V1.0.1	2020-06-02	Updated the description of the H_2xRJ45 IP input card.
V1.0.0	2020-05-15	First release

Introduction

The H2 is NovaStar's newest generation of video wall splicer, featuring excellent image quality and designed especially for fine-pitch LED screens. The H2 can work as splicing processors that integrate both video processing and video control capabilities, or work as pure splicing processors. The whole unit adopts a modular and plug-in design, and allows for flexible configuration and hot swapping of input and output cards. Thanks to excellent features and stable performance, the H2 can be widely used in a variety of applications, such as energy and power, judicial departments and prisons, military command, water conservancy and hydrology, meteorologic earthquake prediction, enterprise management, metallurgy of steel, banking and finance, national defense, public security traffic management, exhibitions and presentations, production scheduling, radio and television, educational and scientific research, as well as stage rental applications.

Based on the powerful hardware FPGA system architecture, with a modular and plug-in design, the H2 features a stable and highly efficient pure hardware architecture, and provides a variety of connector modules for flexible and personalized configuration, allowing for easy maintenance and low failure rate. The H2 provides the industry-standard input connectors, including HDMI, DVI, DP, VGA, CVBS, SDI and IP, and supports 10-bit video source input and processing, as well as 4K high-definition inputs and outputs. The H2 also provides two kinds of LED 4K sending cards, allowing for the backup between the OPT ports and Ethernet ports as well as ultra-long distance transmission. Moreover, the H2 supports multi-screen and multi-layer management, input and output EDID management and monitoring, input source renaming, BKG and OSD settings and more, bringing you a rich image construction experience.

In addition, the H2 adopts the B/S architecture and supports cross-platform, cross-system access and control without the need to install an application program. On a Windows, Mac, iOS, Android or Linux platform, online collaboration of multiple users is supported and the Web page response speed is very fast, which greatly improves on-site setup efficiency. What's more, the H2 supports online firmware update, allowing for easy hardware update on a PC.

Certifications

CE, UKCA, FCC, IC, CB, NOM, RCM, KC, CMIM

If the product does not have the relevant certifications required by the countries or regions where it is to be sold, please contact NovaStar to confirm or address the problem. Otherwise, the customer shall be responsible for the legal risks caused or NovaStar has the right to claim compensation.

Features

Modular and plug-in design, free combination at your will

- Three kinds of LED 4K sending cards
 - H_20xRJ45 sending card loads up to 13,000,000 pixels.
 - H_16xRJ45+2xfiber sending card loads up to 10,400,000 pixels and provides two OPT ports that copy the outputs on Ethernet ports.
 - H_4xfiber sending card loads up to 20,800,000 pixels and supports three working modes, including independent, copy and backup.
- Multi-capacity configuration on a single card slot
 - 4x 2Kx1K@60Hz
 - 2x 4Kx1K@60Hz
 - 1x 4Kx2K@60Hz
- Simple screen configuration using a single card and connector
- Online status monitoring of all input and output cards
- Hot-swappable input and output cards
- H_2xRJ45 IP input card supports up to 512 IP camera inputs and input mosaic.
- Auto decryption of HDCP-encrypted sources
- Decimal frame rates supported
- HDR10 and HLG processing

Multi-screen management for centralized control

- Each screen can have its own output resolution.
- Output mosaic
 - Adopts the frame synchronization technology, which ensures all the output connectors output the image synchronously, and the image is complete and played smoothly, without any stuck, frame loss, tearing or piecing.
- Irregular screen configuration
 - Supports irregular rectangle mosaic without any limitations.

- Input source grouping management
- Eye saver mode
- Display the image in a warmer but less bright way to relieve eye strain.
- LCD bezel compensation

Diverse display possibilities for flexible configuration

- **Multi-layer display**
A single card supports 16x 2K layers, 8x DL layers or 4x 4K layers.
All layers support cross-connector output and the layer quantity is not reduced for cross-connector output.
- **High-definition scrolling text**
Customize the scrolling text content, such as slogans or notification messages, and set the text style, scrolling direction and speed.
- **Up to 2,000 presets**
Fade effect and seamless switching supported, less than 60ms preset switching duration
- **Scheduled playback of preset playlist**
Set whether to add the presets to playlist, which is ideal for monitoring, exhibitions, presentations, and other applications.
- **OSD settings on a single screen and adjustable OSD transparency**
- **BKG settings**
BKG images do not occupy the layer resources.
The max. width and height of a BKG image is up to 15K and 8K respectively.
- **Channel logo management**
Set a text or image logo for identifying the input source.
- **Input source cropping and renaming after cropping**
Crop any input source image and form a new input source after cropping.
- **HDR and 10-bit video processing, allowing for a more exquisite and clear image**
- **Color adjustment**
Output connector color and screen color adjustable, including the brightness, contrast, saturation, hue and Gamma
- **XR scenario control**
- **3D function**
Work with NovaStar's 3D emitter – EMT200 to enjoy the 3D visual effect.
- **Low latency**
Reduce the latency from the input source to the receiving card to as low as 1 frame.

Web-page control, easy, friendly and convenient

- **Web control**
Real-time response and 1000M/100M self-adaptive network control, allowing for multi-user collaboration
- **Monitoring of inputs and outputs on Web page**
- **Firmware update on Web page**
- **Ark Visualized Management and Control Platform app control on pad device**

Status monitoring for better stability and reliability

- **Self-test for fault detection**
- **Auto monitoring and alarms**
Supports hardware monitoring, such as fan rotation speed, module temperature and voltage, running status, and sends fault alarms if necessary.
- **Backup design**
 - Backup between devices
 - Backup between LED 4K sending cards

Appearance

Front Panel



*The picture shown is for illustration purpose only. Actual product may vary due to product enhancement.

Notes:

- This product can only be placed horizontally. Do not mount vertically or upside-down.
- The product can be mounted in a standard 19-inch rack capable of withstanding at least four times the total weight of the mounted equipment. Four M5 screws should be used to fix the product.

Name	Description
LCD screen	Displays the device status and monitoring information.

Rear Panel

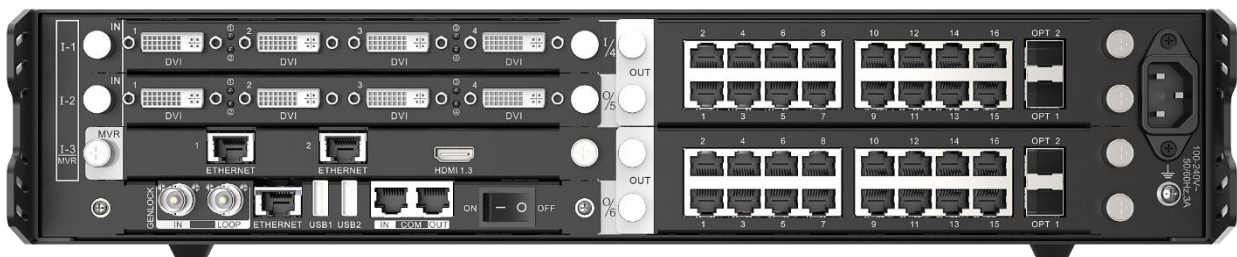

*The picture shown is for illustration purpose only. Actual product may vary due to product enhancement.

Notes:

- The silkscreen marking "I-x" or "I/x" indicates the slot is dedicated to the input card. "I" stands for input and "x" stands for the slot number. For example, "I-1" indicates this slot is the 1st input slot and for installing an input card only.
- The silkscreen marking "O-x" or "O/x" indicates the slot is dedicated to the output card. "O" stands for output and "x" stands for the slot number. For example, "O-10" indicates this slot is the 10th output slot and for installing an output card only.
- The silkscreen marking " $\frac{I-x}{MVR}$ " indicates the slot can accept an input card or preview card.

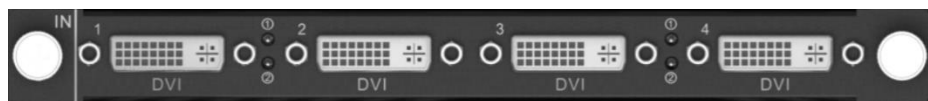

Input Card

H_4xDVI input card





Support for single link and dual link input modes, and 10-bit input source
 HDCP 1.4 compliant
 Does not support interlaced signal input.

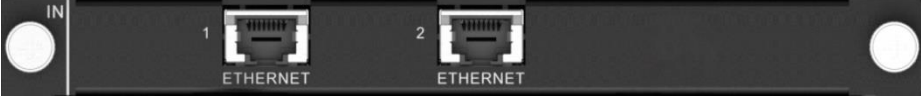
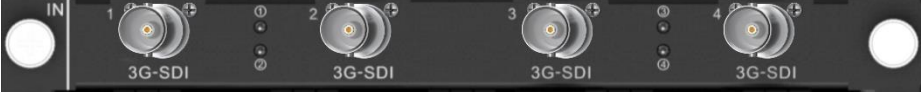
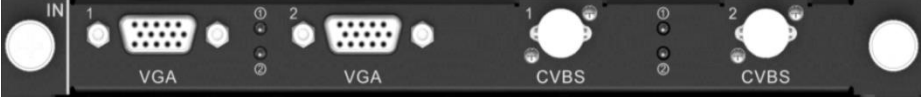

- Single link mode:

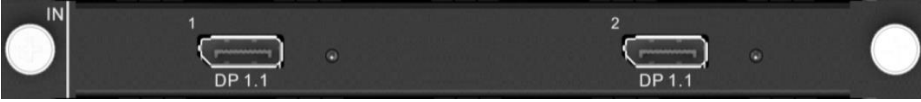
	<ul style="list-style-type: none"> - Four DVI connectors are all used for input. - Each connector supports the maximum resolution of 2048x1152@60Hz and the minimum resolution of 800x600@60Hz. - Custom resolutions: Max. width: 2560 pixels (2560x972@60Hz) Max. height: 2560 pixels (884x2560@60Hz) • Dual link mode: <ul style="list-style-type: none"> - Connectors 2 and 4 are used for input, and connectors 1 and 3 are unavailable. - Each connector supports the maximum resolution of 3840x1080@60Hz and the minimum resolution of 800x600@60Hz. - Custom resolutions: Max. width: 3840 pixels (3840x1124@60Hz) Max. height: 4095 pixels (1014x4095@60Hz) <p>Status LEDs:</p> <ul style="list-style-type: none"> • On: The input source is accessed normally. • Off: No input source is accessed or the input source is abnormal.
<p>H_4xHDMI input card</p>	 <p>Support for 10-bit input source Does not support interlaced signal input.</p> <p>For HDMI 1.3 inputs:</p> <ul style="list-style-type: none"> • Four connectors are all used for input. • Each connector supports the maximum resolution of 2048x1152@60Hz, and the minimum resolution of 800x600@60Hz. • Custom resolutions: Max. width: 2560 pixels (2560x972@60Hz) Max. height: 2560 pixels (884x2560@60Hz) • HDCP 1.4 compliant <p>For HDMI 1.4 inputs:</p> <ul style="list-style-type: none"> • Two HDMI 1.4 connectors are used for input, but two HDMI 1.3 connectors are unavailable. • Each connector supports the maximum resolution of 3840x1080@60Hz. • Custom resolutions: Max. width: 3840 pixels (3840x1124@60Hz) Max. height: 4095 pixels (1014x4095@60Hz) • HDCP 1.4 compliant <p>Status LEDs:</p> <ul style="list-style-type: none"> • On: The input source is accessed normally. • Off: No input source is accessed or the input source is abnormal.
<p>H_1xHDMI2.0+1xDP1.2 input card</p>	 <p>Only one connector can be used each time.</p> <p>Set to use which connector on the Web page. The default option is HDMI 2.0 connector. Does not support interlaced signal input.</p>

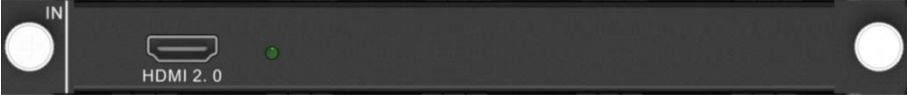
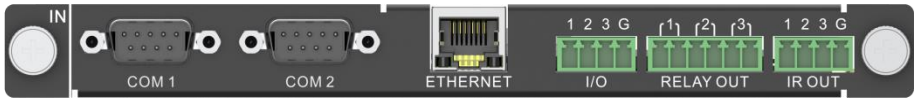
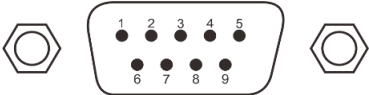

	<ul style="list-style-type: none"> ● 1x HDMI 2.0 <ul style="list-style-type: none"> - Backward compatible with HDMI 1.4 and HDMI 1.3 - Supports the maximum resolution of 3840×2160@60Hz. - HDCP 2.2 compliant - Custom resolutions: <ul style="list-style-type: none"> Max. width: 4092 pixels (4092×2261 @60Hz) Max. height: 4095 pixels (2188×4095 @60Hz) ● 1x DP 1.2 <ul style="list-style-type: none"> - Backward compatible with DP 1.1 - Supports the maximum resolution of 4096×2160@60Hz or 8192×1080@60Hz. - HDCP 2.2 compliant - Custom resolutions: <ul style="list-style-type: none"> Max. width: 8192 pixels (8192×1146 @60Hz) Max. height: 4095 pixels (2188×4095 @60Hz) <p>Status LEDs:</p> <ul style="list-style-type: none"> ● On: The input source is accessed normally. ● Off: No input source is accessed or the input source is abnormal.
<p>H_2xRJ45 IP input card</p>	 <p>2x RJ45 Gigabit Ethernet ports</p> <p>Support for interlaced signal input</p> <ul style="list-style-type: none"> ● Supported protocols: RTSP, GB28181 and ONVIF ● Supported coding formats: H.264 and H.265 ● Single card decoding capability: <ul style="list-style-type: none"> - 4x 800 W - 8x 400 W - 16x 200 W ● DHCP compliant
<p>H_4x3G SDI input card</p>	 <p>4x 3G-SDI</p> <ul style="list-style-type: none"> ● Backward compatible with HD-SDI and SD-SDI ● Supports ST-424 (3G), ST-292 (HD) and SMPTE 259 SD. ● Each connector supports the maximum resolution of 1920×1080@60Hz. ● Supports 1080i/576i/480i de-interlacing processing. <p>Status LEDs:</p> <ul style="list-style-type: none"> ● On: The input source is accessed normally. ● Off: No input source is accessed or the input source is abnormal.
<p>H_2xCVBS+2xVGA input card</p>	 <p>2x VGA</p> <ul style="list-style-type: none"> ● Each connector supports the maximum resolution of 1920×1200@60Hz. <p>2x CVBS</p> <ul style="list-style-type: none"> ● Supports PAL and NTSC.

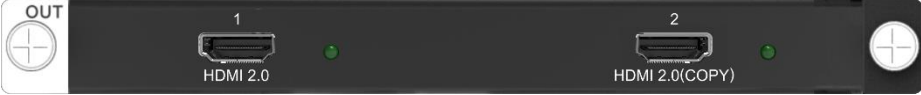
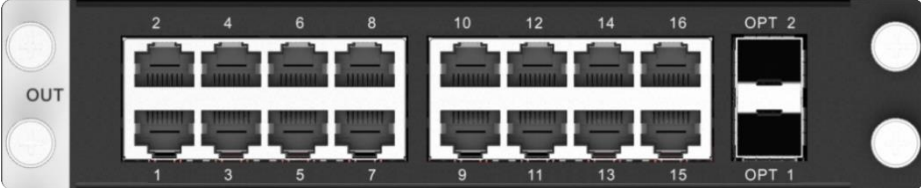

	<p>Status LEDs:</p> <ul style="list-style-type: none"> ● On: The input source is accessed normally. ● Off: No input source is accessed or the input source is abnormal.
H_4xVGA input card	 <p>4x VGA</p> <ul style="list-style-type: none"> ● Each connector supports the maximum resolution of 1920x1200@60Hz. <p>Status LEDs:</p> <ul style="list-style-type: none"> ● On: The input source is accessed normally. ● Off: No input source is accessed or the input source is abnormal.
H_2xDP1.1 input card	 <p>2x DP1.1</p> <ul style="list-style-type: none"> ● Each connector supports the maximum resolution of 3840x1080@60Hz or 3840x2160@30Hz. ● Custom resolutions: <ul style="list-style-type: none"> – Max. width: 3840 pixels (3840x1124@60Hz) – Max. height: 4095 pixels (1014x4095@60Hz) ● Supports 8-bit and 10-bit inputs. ● Does not support interlaced signal input. ● HDCP 1.3 compliant <p>Status LEDs:</p> <ul style="list-style-type: none"> ● On: The input source is accessed normally. ● Off: No input source is accessed or the input source is abnormal.
H_1xDP1.2 input card	 <p>1x DP 1.2</p> <ul style="list-style-type: none"> ● Backward compatible with DP 1.1 ● Each connector supports the maximum resolution of 4096x2160@60Hz or 8192x1080@60Hz. ● Custom resolutions: <ul style="list-style-type: none"> – Max. width: 8192 pixels (8192x1146@60Hz) – Max. height: 4095 pixels (2188x4095@60Hz) ● HDCP 2.2 compliant <p>Status LEDs:</p> <ul style="list-style-type: none"> ● On: The input source is accessed normally. ● Off: No input source is accessed or the input source is abnormal.
H_1x12G SDI input card	 <p>● 1x 12G-SDI IN</p> <ul style="list-style-type: none"> – Backward compatible with 6G-SDI, 3G-SDI, HD-SDI and SD-SDI – Supports ST-2082-1 (12G), ST-2081-1 (6G), ST-424 (3G), ST-292 (HD) and SMPTE 259 SD. – Each connector supports the maximum resolution of 4096x2160@60Hz.

	<ul style="list-style-type: none"> - Supports 1080i/576i/480i de-interlacing processing. - Does not support input resolution and bit depth settings. • 1x 12G-SDI LOOP <ul style="list-style-type: none"> Loop out the 12G-SDI signal. • Status LEDs: <ul style="list-style-type: none"> - On: The input or loop output is connected normally. - Off: No input or loop output is connected or the input or loop output is abnormal. 																																								
<p>H_1xHDMI2.0 input card</p>	 <p>1x HDMI 2.0</p> <ul style="list-style-type: none"> • Backward compatible with HDMI 1.4 and HDMI 1.3 • Each connector supports the maximum resolution of 3840×2160@60Hz. • HDCP 2.2 compliant • Custom resolutions: <ul style="list-style-type: none"> - Max. width: 4092 pixels (4092×2261@60Hz) - Max. height: 4095 pixels (2188×4095@60Hz) • Status LEDs: <ul style="list-style-type: none"> - On: The input source is accessed normally. - Off: No input source is accessed or the input source is abnormal. 																																								
<p>H_STD I/O card</p>	 <p>This card can be installed into the input card slots.</p> <ul style="list-style-type: none"> • 2x COM <p>Programmable RS422/RS485/RS232 ports that are used to control the devices that adopt RS422/RS485/RS232 protocol</p> <ul style="list-style-type: none"> - COM port pins are shown as below:  <ul style="list-style-type: none"> - Pin wirings are shown as below: <table border="1" data-bbox="574 1444 1161 1697"> <thead> <tr> <th>PIN</th> <th>1</th> <th>2</th> <th>3</th> <th>4</th> <th>5</th> <th>6</th> <th>7</th> <th>8</th> <th>9</th> </tr> </thead> <tbody> <tr> <td>RS-232</td> <td colspan="2">—RXD—TXD—</td> <td colspan="3">—GND—</td> <td colspan="4"></td> </tr> <tr> <td>RS-422</td> <td>RXD-</td> <td colspan="2">—TXD+</td> <td>GND</td> <td>RXD+</td> <td colspan="4">—TXD-</td> </tr> <tr> <td>RS-485</td> <td colspan="4">—A—</td> <td colspan="5">—B—</td> </tr> </tbody> </table> • 1x ETHERNET <ul style="list-style-type: none"> - Control the device that is connected to this card. - 10/100Mbps self-adaptive - TCP/IP protocol and UDP/IP protocol supported • 3x I/O <ul style="list-style-type: none"> - Trigger the execution of the function requirements via programming. - Input and output modes supported - Pins 1, 2 and 3 can be set to either the input or output, and pin G is the common grounding pin for pins 1, 2 and 3. 	PIN	1	2	3	4	5	6	7	8	9	RS-232	—RXD—TXD—		—GND—							RS-422	RXD-	—TXD+		GND	RXD+	—TXD-				RS-485	—A—				—B—				
PIN	1	2	3	4	5	6	7	8	9																																
RS-232	—RXD—TXD—		—GND—																																						
RS-422	RXD-	—TXD+		GND	RXD+	—TXD-																																			
RS-485	—A—				—B—																																				

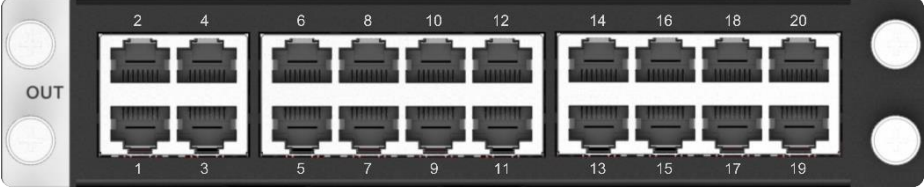
	<ul style="list-style-type: none"> • 3x RELAY OUT <ul style="list-style-type: none"> – Connect to the relay to control the power on and off of the connected device. – Voltage: 30 VDC, current: 3A at maximum – Six pins are divided into three groups, which can be connected or disconnected via programming. • 3x IR OUT <ul style="list-style-type: none"> – Programmable infrared control supported – Pins 1, 2 and 3 are used for infrared emission, and pin G is the common grounding pin for pins 1, 2 and 3.
Output Card	
H_4xDVI output card	 <p>4x SL-DVI</p> <p>Support for single output and dual link output</p> <ul style="list-style-type: none"> • Single link output: <ul style="list-style-type: none"> – Four connectors are all available for output. – Each connector supports the maximum resolution of 2048x1152@60Hz. – Custom resolutions: <ul style="list-style-type: none"> Max. width: 2560 pixels (2560x972@60Hz) Max. height: 2560 pixels (884x2560@60Hz) – Supports 8-bit RGB 4:4:4/YCbCr 4:4:4/YCbCr 4:2:2 output. – Supports 10-bit YCbCr 4:4:4 output. • Dual link output: <ul style="list-style-type: none"> – Connectors 2 and 4 are available for output. – Connector 1 copies the output on connector 2, and connector 3 copies the output on connector 4. – Adopts HDMI 1.4 protocol. – Each connector supports the maximum resolution of 4096x2160@30Hz/3840x1080@60Hz. – Custom resolutions: <ul style="list-style-type: none"> Max. width: 4096 pixels (4096x1124@60Hz) Max. height: 4096 pixels (1014x4096@60Hz) – Supports 8-bit RGB 4:4:4/YCbCr 4:4:4/YCbCr 4:2:2 output. – Supports 10-bit YCbCr 4:4:4 output. <p>Status LEDs:</p> <ul style="list-style-type: none"> • On: The output connector is connected normally. • Off: The output connector is not connected.
H_4xHDMI output card	 <p>4x HDMI 1.4</p> <p>Support for single output and dual link output</p> <ul style="list-style-type: none"> • Single link output: <ul style="list-style-type: none"> – Four connectors are all available for output. – Each connector supports the maximum resolution of 2048x1152@60Hz. – Custom resolutions: <ul style="list-style-type: none"> Max. width: 2560 pixels (2560x972@60Hz) Max. height: 2560 pixels (884x2560@60Hz)

	<ul style="list-style-type: none"> - Supports 8-bit RGB 4:4:4/YCbCr 4:4:4/YCbCr 4:2:2 output. - Supports 10-bit RGB 4:4:4/YCbCr 4:4:4 output. • Dual link output: <ul style="list-style-type: none"> - Connectors 2 and 4 are available for output. Connector 1 copies the output on connector 2, and connector 3 copies the output on connector 4. - Each connector supports the maximum resolution of 4096x2160@30Hz/3840x1080@60Hz. - Custom resolutions: Max. width: 4096 pixels (4096x1124@60Hz) Max. height: 4096 pixels (1014x4096@60Hz) - Supports 8-bit RGB 4:4:4/YCbCr 4:4:4/YCbCr 4:2:2 output. - Supports 10-bit RGB 4:4:4/YCbCr 4:4:4 output. <p>Status LEDs:</p> <ul style="list-style-type: none"> • On: The output connector is connected normally. • Off: The output connector is not connected.
<p>H_1xHDMI2.0 output card</p>	 <ul style="list-style-type: none"> • 2x HDMI 2.0 <ul style="list-style-type: none"> - Connector 2 copies the output on connector 1. - The connector supports the maximum resolution of 8192x1080@60Hz/4096x2160@60Hz. - Custom resolutions: Max. width: 8192 pixels (8192x1146@60Hz) Max. height: 7680 pixels (1092x7680@60Hz) - Supports 8-bit or 10-bit RGB 4:4:4/YCbCr 4:4:4/YCbCr 4:2:2 output. • Status LEDs: <ul style="list-style-type: none"> - On: The output connector is connected normally. - Off: The output connector is not connected.
<p>H_16xRJ45+2xfiber sending card</p>	 <p>LED 4K sending card can load up to 10,400,000 pixels (max. width: 10,240 pixels, max. height: 10,240 pixels).</p> <p>This card occupies two slots.</p> <ul style="list-style-type: none"> • 16x RJ45 Gigabit Ethernet outputs <ul style="list-style-type: none"> - Bit depth: 8-bit A single Ethernet port loads up to 650,000 pixels. - Bit depth: 10-bit A single Ethernet port loads up to 320,000 pixels. - Backup between Ethernet ports • 2x OPT outputs <ul style="list-style-type: none"> - Support both SMF and MMF transmission. - OPT 1 copies and outputs the data on Ethernet ports 1–8. - OPT 2 copies and outputs the data on Ethernet ports 9–16.

	<p>Note:</p> <p>For the optical module connected to the OPT port, you need to order or purchase separately.</p>
<p>H_20xRJ45 sending card</p>	 <p>LED 4K sending card can load up to 13,000,000 pixels (max. width: 10,752 pixels, max. height: 10,752 pixels).</p> <p>This card occupies two slots.</p> <ul style="list-style-type: none"> ● 20x RJ45 Gigabit Ethernet outputs <ul style="list-style-type: none"> – Bit depth: 8-bit A single Ethernet port loads up to 650,000 pixels. – Bit depth: 10-bit A single Ethernet port loads up to 320,000 pixels. ● Backup between Ethernet ports
<p>H_4xfiber sending card</p>	 <p>4x 10G OPT ports</p> <p>This card can load up to 20,800,000 pixels (max. width: 16,384 pixels, max. height: 16,384 pixels)</p> <ul style="list-style-type: none"> ● Independent, copy and backup modes are supported. ● SM and MM optical modules are both supported, with a transmission distance of up to 10 km. ● Supports 8-bit and 10-bit outputs. ● The optical module supports SFP+ encapsulation. The supported module specifications include the followings: <ul style="list-style-type: none"> – 10G SFP+ SR optical module – 10G SFP+ LRM optical module – 10G SFP+ LR optical module – 10G SFP+ ER optical module – 10G SFP+ ZR optical module – SFP+ CWDM optical module – SFP+ DWDM optical module – SFP+ BIDI optical module <p>Independent Four OPT ports are all used for output and have the same loading capacity. The loading capacity of one port is equal to that of 8 Ethernet ports.</p> <p>Copy OPT 1 and OPT 2 are used for main output. OPT 3 copies the output on OPT 1, while OPT 4 copies the output on OPT 2.</p> <p>Backup OPT 1 and OPT 2 are used for main output. OPT 3 serves as the backup of OPT 1, while OPT 4 serves as the backup of OPT 2.</p> <p>Note:</p> <p>Four 10G SFP+ LR optical modules are included with the card and are already installed into the OPT ports.</p>

<p>H_2xRJ45+1xHDMI1.3 preview card</p>	 <ul style="list-style-type: none"> • 2x RJ45 Gigabit Ethernet outputs Connect to the network for monitoring the inputs and outputs. • 1x HDMI 1.3 Connect to a monitor for displaying the monitoring information.
<p>H_Control Card</p>	
	
<p>GENLOCK</p>	<p>Supports bi-level and tri-level.</p> <ul style="list-style-type: none"> • IN: Accept the Genlock signal • LOOP: Loop the Genlock signal.
<p>ETHERNET</p>	<p>A Gigabit Ethernet port</p> <ul style="list-style-type: none"> • Connect to the control PC for communication. • Connect to the router, switch or PC. • For Web control and NovaLCT screen configuration
<p>USB 1 & USB 2</p>	<p>2x USB 2.0</p> <ul style="list-style-type: none"> • Update the device program. • Import or export the device configuration parameters. <p>Note:</p> <p>The USB connectors cannot provide power for the connected devices.</p>
<p>COM</p>	<p>A serial port that adopts RS232 serial protocol</p> <p>Support for central control system</p> <ul style="list-style-type: none"> • IN: Accept the signal from the central control system. • OUT: Loop the signal. <p>Note:</p> <p>The COM port cannot be connected to the network (router or switch) or LED cabinet (receiving card).</p>
<p>Power switch</p>	<ul style="list-style-type: none"> • – / ON: Power on the device. • O / OFF: Power off the device.

Applications

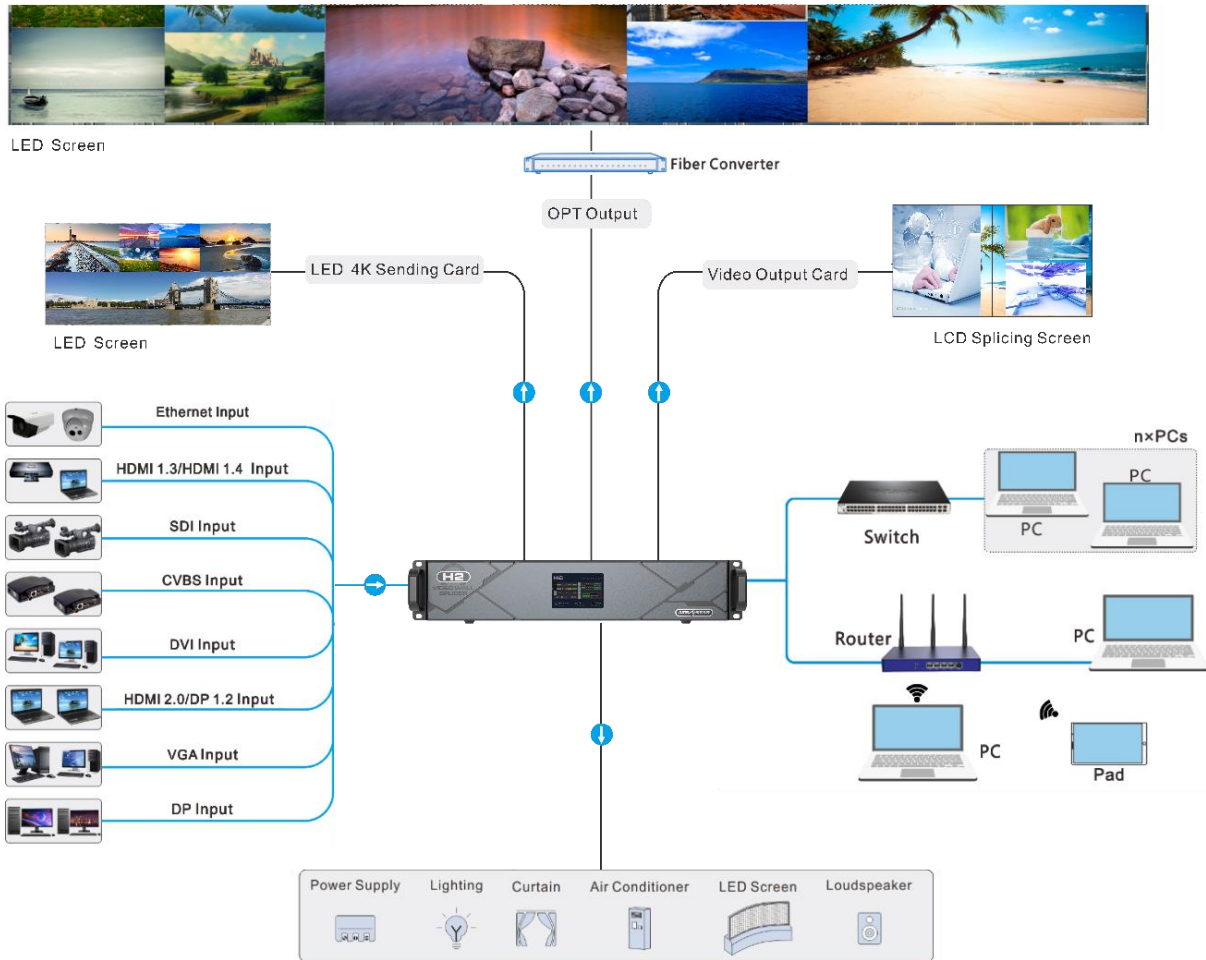

Dimensions

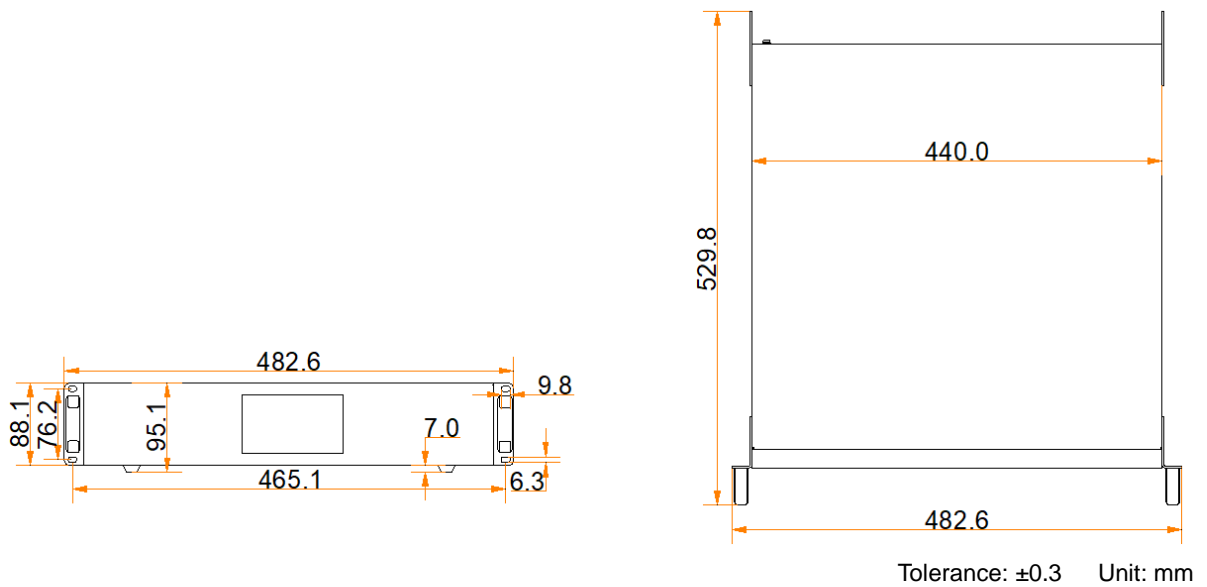

Specifications

Model		H2
Rack Unit		2U
Max. Input Cards		4
Max. Input Channels		16
Max. Output Cards		2
Max. Output Channels		8
Max. Loading Capacity	LED 4K sending card	26 million pixels
	H_4xfiber sending card	41.6 million pixels
Max. Layers		32
Electrical Specifications	Power connector	100–240V~, 50/60Hz, 4.0A
	Power consumption	210 W
Operating Environment	Temperature	0°C to 45°C
	Humidity	0% RH to 80% RH, non-condensing
Storage Environment	Temperature	–10°C to +60°C
	Humidity	0% RH to 95% RH, non-condensing
Physical Specifications	Dimensions	482.6 mm × 529.8 mm × 88.1 mm
	Net weight	11 kg (chassis)
	Gross weight	12.2 kg (chassis)
Noise Level (typical at 25°C /77°F)		< 45 dB (A)
Packing Information	Packing box	660 mm × 570 mm × 210 mm
	Accessories	<ul style="list-style-type: none"> 1x Power cord 1x RJ45 Ethernet cable 1x Grounding cable 1x HDMI cable 1x Quick Start Guide 1x Certificate of Approval 1x Safety Manual 1x Custom Letter

Video Source Features

Input Connector	Color Depth		Max. Input Resolution	
HDMI 2.0	8-bit	RGB 4:4:4	4096x2160@60Hz	
		YCbCr 4:4:4	8192x1080@60Hz	
		YCbCr 4:2:2		
		YCbCr 4:2:0	4096x2160@60Hz	
	10-bit	RGB 4:4:4	4096x2160@30Hz	
		YCbCr 4:4:4	4096x1080@60Hz	
		YCbCr 4:2:2	4096x2160@60Hz	
		YCbCr 4:2:0		
	12-bit	RGB 4:4:4	4096x2160@30Hz	
		YCbCr 4:4:4	4096x1080@60Hz	
		YCbCr 4:2:2	4096x2160@60Hz	
		YCbCr 4:2:0		
DP 1.2	8-bit	RGB 4:4:4	4096x2160@60Hz	
		YCbCr 4:4:4	8192x1080@60Hz	
		YCbCr 4:2:2		
		YCbCr 4:2:0	Not supported	
	10-bit	RGB 4:4:4	4096x2160@30Hz	
		YCbCr 4:4:4	4096x1080@60Hz	
		YCbCr 4:2:2	4096x2160@60Hz	
		YCbCr 4:2:0	Not supported	
	12-bit	RGB 4:4:4	4096x2160@30Hz	
		YCbCr 4:4:4	4096x1080@60Hz	
		YCbCr 4:2:2	4096x2160@60Hz	
		YCbCr 4:2:0	Not supported	
	HDMI 1.4 DP 1.1	8-bit	RGB 4:4:4	4096x1080@60Hz
			YCbCr 4:4:4	
			YCbCr 4:2:2	
			YCbCr 4:2:0	Not supported
10-bit		RGB 4:4:4	2048x1152@60Hz	

Input Connector	Color Depth		Max. Input Resolution
		YCbCr 4:4:4	
		YCbCr 4:2:2	4096×1080@60Hz
		YCbCr 4:2:0	Not supported
	12-bit	RGB 4:4:4	2048×1152@60Hz
		YCbCr 4:4:4	
		YCbCr 4:2:2	4096×1080@60Hz
		YCbCr 4:2:0	Not supported
HDMI 1.3	8-bit	RGB 4:4:4	2048×1152@60Hz
		YCbCr 4:4:4	
		YCbCr 4:2:2	
		YCbCr 4:2:0	Not supported
	10-bit	RGB 4:4:4	2048×1152@60Hz
		YCbCr 4:4:4	
		YCbCr 4:2:2	
		YCbCr 4:2:0	Not supported
	12-bit	RGB 4:4:4	2048×1152@60Hz
		YCbCr 4:4:4	
		YCbCr 4:2:2	
		YCbCr 4:2:0	Not supported
SL-DVI	8-bit	RGB 4:4:4	2048×1152@60Hz
DL-DVI	8-bit	RGB 4:4:4	3840×1080@60Hz
VGA CVBS	-	RGB 4:4:4	1920×1080@60Hz
3G-SDI	<ul style="list-style-type: none"> • Supports up to 1920×1080@60Hz video inputs. • Input resolution and bit depth settings are not allowed. • Supports ST-424 (3G) and ST-292 (HD). 		
12G-SDI	<ul style="list-style-type: none"> • Supports up to 4096×2160@60Hz video inputs. • Input resolution and bit depth settings are not allowed. • Supports ST-2082-1 (12G), ST-2081-1 (6G), ST-424 (3G) and ST-292 (HD). 		

Notes and Cautions

Notes For Battery

- The battery is not intended to be replaced.
- Disposal of a battery into fire or a hot oven, or mechanically crushing or cutting of a battery can result in an explosion.
- Leaving a battery in an extremely high temperature surrounding environment can result in an explosion or the leakage of flammable liquid or gas.
- A battery subjected to extremely low air pressure may result in an explosion or the leakage of flammable liquid or gas.

Notes for Installation

When the product needs to be installed on the rack, 8 screws at least M5*8 should be used to fix it. The rack for installation shall bear at least four times the total weight of the mounted equipment.

- A. Elevated Operating Ambient - If installed in a closed or multi-unit rack assembly, the operating ambient temperature of the rack environment may be greater than room ambient. Therefore, consideration should be given to installing the equipment in an environment compatible with the maximum ambient temperature (T_{ma}) specified by the manufacturer.
- B. Reduced Air Flow - Installation of the equipment in a rack should be such that the amount of air flow required for safe operation of the equipment is not compromised.
- C. Mechanical Loading - Mounting of the equipment in the rack should be such that a hazardous condition is not achieved due to uneven mechanical loading.
- D. Circuit Overloading - Consideration should be given to the connection of the equipment to the supply circuit and the effect that overloading of the circuits might have on overcurrent protection and supply wiring. Appropriate consideration of equipment nameplate ratings should be used when addressing this concern.
- E. Reliable Earthing - Reliable earthing of rack-mounted equipment should be maintained. Particular attention should be given to supply connections other than direct connections to the branch circuit (e.g. use of power strips).

FCC Caution

Any changes or modifications not expressly approved by the party responsible for compliance could void the user's authority to operate the equipment.

This device complies with part 15 of the FCC Rules. Operation is subject to the following two conditions: (1) This device may not cause harmful interference, and (2) this device must accept any interference received, including interference that may cause undesired operation.

Note: This equipment has been tested and found to comply with the limits for a Class A digital device, pursuant to part 15 of the FCC Rules. These limits are designed to provide reasonable protection against harmful interference when the equipment is operated in a commercial environment. This equipment generates, uses, and can radiate radio frequency energy and, if not installed and used in accordance with the instruction manual, may cause harmful interference to radio communications. Operation of this equipment in a residential area is likely to cause harmful interference in which case the user will be required to correct the interference at his own expense.

Others

- This is Class A product. In a domestic environment, this product may cause radio interference in which case the user may be required to take adequate measures.
- Please read the specifications thoroughly and use the product in accordance with the requirements. If you have any questions about the specifications, please contact us immediately. If you use the product improperly, not following the requirements, or for illegal purposes, you shall be solely responsible for any consequences arising therefrom.

Copyright © 2023 Xi'an NovaStar Tech Co., Ltd. All Rights Reserved.

No part of this document may be copied, reproduced, extracted or transmitted in any form or by any means without the prior written consent of Xi'an NovaStar Tech Co., Ltd.

Trademark

 is a trademark of Xi'an NovaStar Tech Co., Ltd.

Statement

Thank you for choosing NovaStar's product. This document is intended to help you understand and use the product. For accuracy and reliability, NovaStar may make improvements and/or changes to this document at any time and without notice. If you experience any problems in use or have any suggestions, please contact us via the contact information given in this document. We will do our best to solve any issues, as well as evaluate and implement any suggestions.

[Official website](http://www.novastar.tech)
www.novastar.tech

[Technical support](mailto:support@novastar.tech)
support@novastar.tech